



R28i Modular Encoder Cable Options

Click on your selection from list below to view cable print.

R8 connector, LD output

R8 connector, PP output

R5 connector, PP output

NOTES: UNLESS OTHERWISE SPECIFIED

1. PART # 677817-04.

TERMINATION		
PIN NO.	COLOR	FUNCTION
1	WHT/ORN	Z-
2	WHT/BLU	B-
3	RED	+5V
4	ORN	Z
5	BLU	B
6	BLK	GND
7	YEL	A
8	WHT/YEL	A-

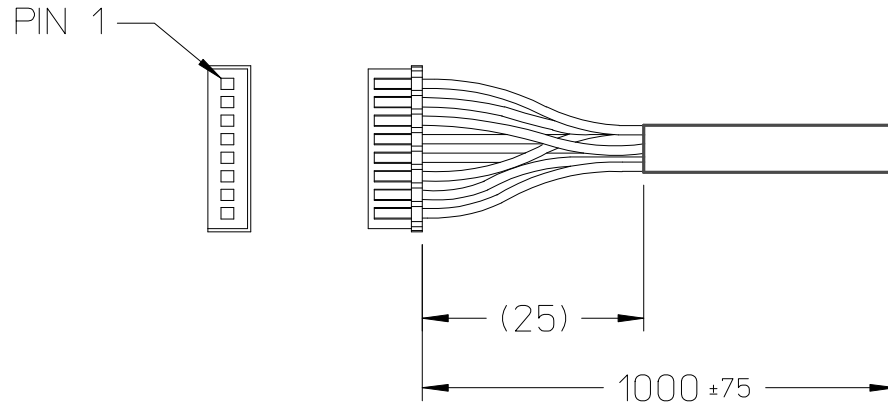

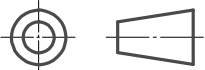
RELEASE # 03372		TEXT Initial release		 RENCO ENCODERS INC. 26 COROMAR DR GOLETA, CA. 93117					
This document is the property of Renco Encoders Inc. and is submitted in confidence. Disclosure, reproduction or publication without written authorization is prohibited.		DRAWN	Cepeda				03/24/09	TITLE	
		APPV'D						Connecting cable, R28i, LD, 8 pin, 1M, web print	
MAT'L	FINISH	TOLERANCES UNLESS OTHERWISE SPECIFIED ALL DIMENSIONS ARE IN MILLIMETERS		SIZE	FSCM NO.	DWG NO.	VER	REV	SHT
THIRD ANGLE PROJECTION 				A	34479	678116-01-A-01			
				SCALE	NONE	THIS DWG PREPARED IN ACCORDANCE WITH: ASME Y14.5M -1994		PAGE 1 OF 1	

D521878-01-A-01

NOTES: UNLESS OTHERWISE SPECIFIED

1. PART # 677859-04.

TERMINATION		
PIN NO.	COLOR	FUNCTION
1	---	N/C
2	---	N/C
3	RED	+5V
4	ORN	Z
5	BLU	B
6	BLK	GND
7	YEL	A
8	---	N/C

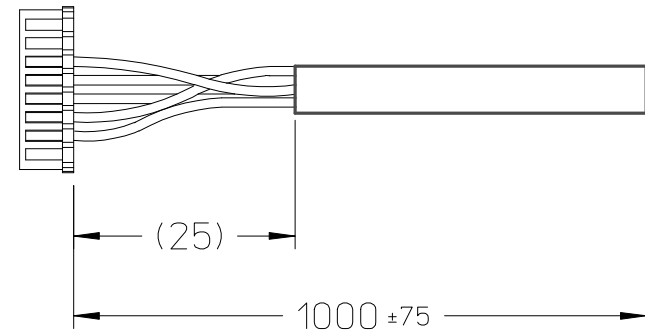
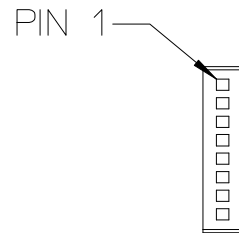

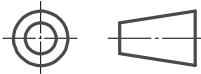
RELEASE # 03372		TEXT Initial release		 RENCO ENCODERS INC. 26 COROMAR DR GOLETA, CA. 93117							
This document is the property of Renco Encoders Inc. and is submitted in confidence. Disclosure, reproduction or publication without written authorization is prohibited.		DRAWN	Cepeda					03/24/09	TITLE		
		APPV'D							Connecting cable, R28i, PP, 5 cond, 1M, web print		
MAT'L		FINISH		TOLERANCES UNLESS OTHERWISE SPECIFIED ALL DIMENSIONS ARE IN MILLIMETERS		SIZE	FSCM NO.	DWG NO.	VER	REV	SHT
THIRD ANGLE PROJECTION						A	34479	678117-01-A-01			
						SCALE	NONE	THIS DWG PREPARED IN ACCORDANCE WITH: ASME Y14.5M -1994		PAGE 1 OF 1	

D521878-01-A-01

NOTES: UNLESS OTHERWISE SPECIFIED

1. PART # 677862-04.

TERMINATION		
PIN NO.	FUNCTION	COLOR
1	+5V	RED
2	Z	ORN
3	B	BLU
4	GND	BLK
5	A	YEL

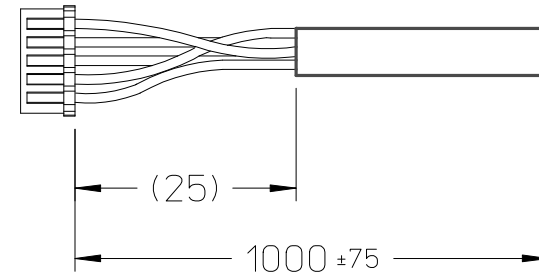
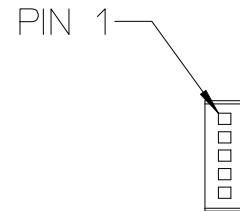

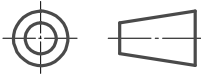
RELEASE # 03372		TEXT Initial release		 RENCO ENCODERS INC. 26 COROMAR DR GOLETA, CA. 93117				
This document is the property of Renco Encoders Inc. and is submitted in confidence. Disclosure, reproduction or publication without written authorization is prohibited.		DRAWN	Cepeda				03/24/09	TITLE
		APPV'D						
MAT'L		FINISH		TOLERANCES UNLESS OTHERWISE SPECIFIED ALL DIMENSIONS ARE IN MILLIMETERS				
THIRD ANGLE PROJECTION				SIZE A	FSCM NO. 34479	DWG NO. 678118-01-A-01		
				SCALE NONE	THIS DWG PREPARED IN ACCORDANCE WITH: ASME Y14.5M -1994	VER REV SHT PAGE 1 OF 1		

D521878-01-A-01